

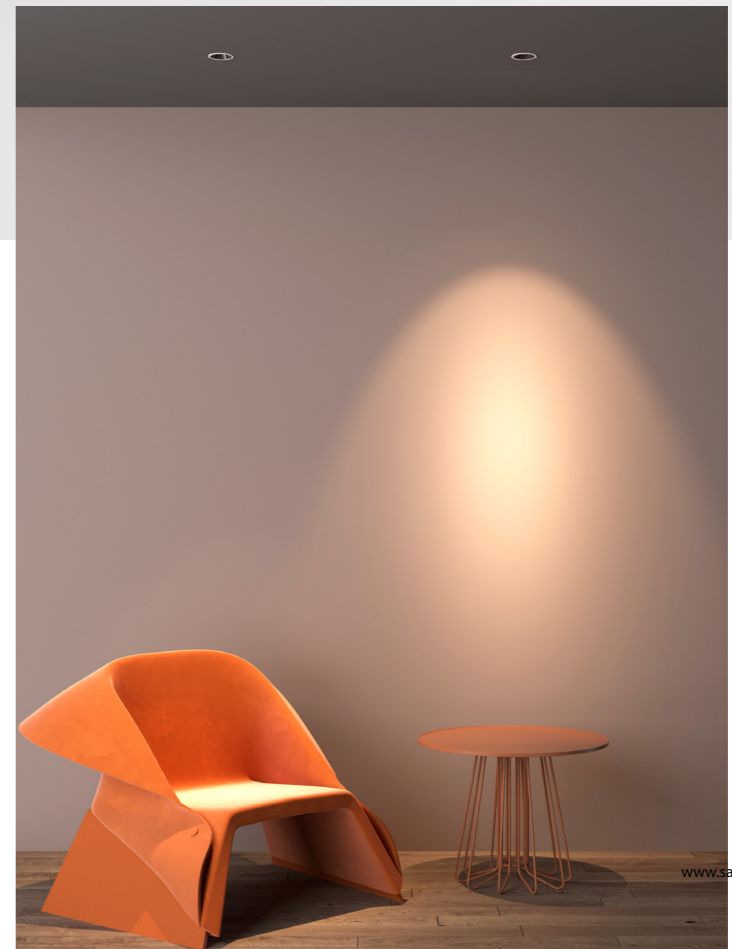

HERA

- Hera is a family of recessed LED spots that comes in a wide range of different sizes and glare-limiting reflector finishes.
- Symmetrical or asymmetrical optics - either fixed or tiltable - are available.
- The variety of luminous flux, appearance options and dimming protocols present Hera as an unbeatable option for architectural lighting applications.





	DDI040Y recessed	DDI055Y recessed	DDI065Y recessed	DDI075Y recessed	DDI085Y recessed
General Information					
Optics	10°/15°/24° Fixed	15°/24°/36° Fixed	15°/24°/36° Fixed	15°/24°/36° Fixed	15°/24°/36° Fixed
System Power (Watt)	5W	5W	7W	9W	15W
System Luminous flux (lm)	250lm	300lm	500lm	680lm	1050lm
Driver parameters	3V/1000mA	36V/110mA	36V/160mA	36V/210mA	36V/360mA
Cut out (mm)	Φ40	Φ55	Φ65	Φ75	Φ85

Technical Details

Light Source	LED SMD	LED COB
Colour temperature	2700K/3000K/4000K	
CRI (Ra/R9)	RA>90/R9>50	
Colour Consistency	SDCM<5	SDCM<3
UGR	<16	
IP-rated	IP20	
Lifetime	>50,000h	
Warranty	3 Years/5 Years	
Driver	ON/OFF, Phase, 0-10V, Dali	

Dimensions (mm)

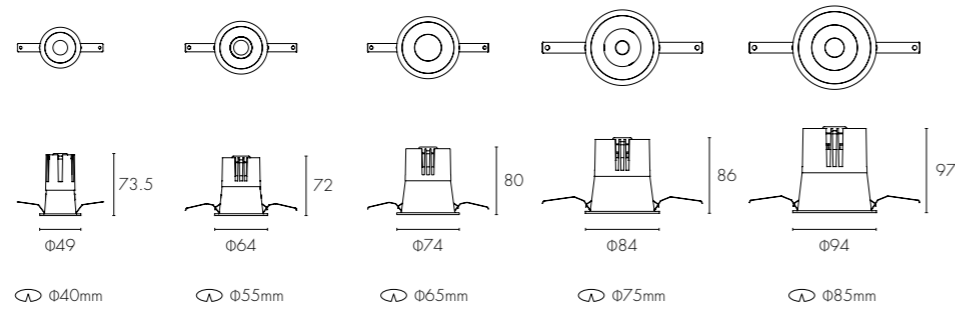

PHOTOMETRIC

DDI040Y 5W

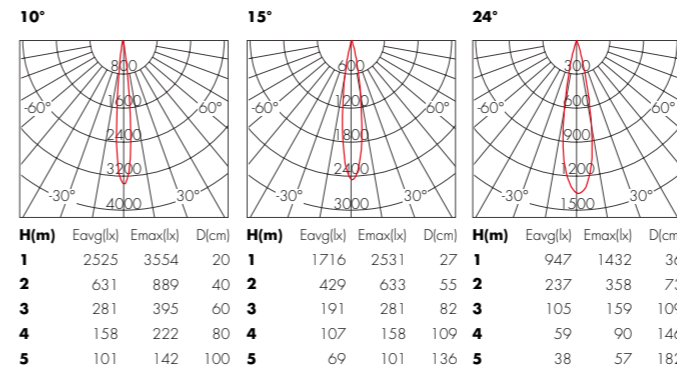

DDI055Y 5W

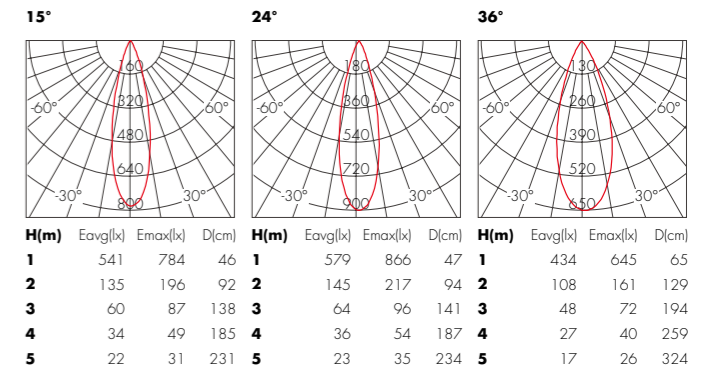

DDI065Y 7W

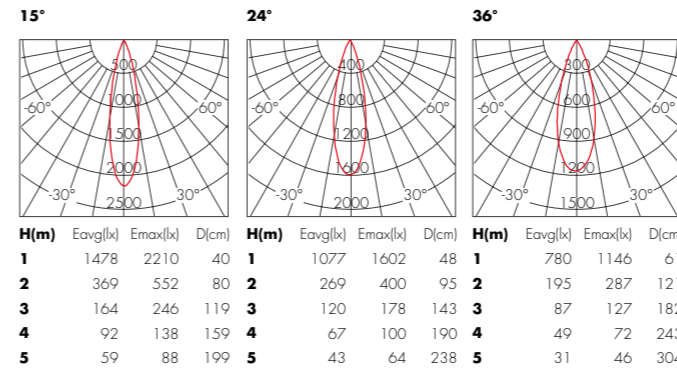

DDI075Y 9W

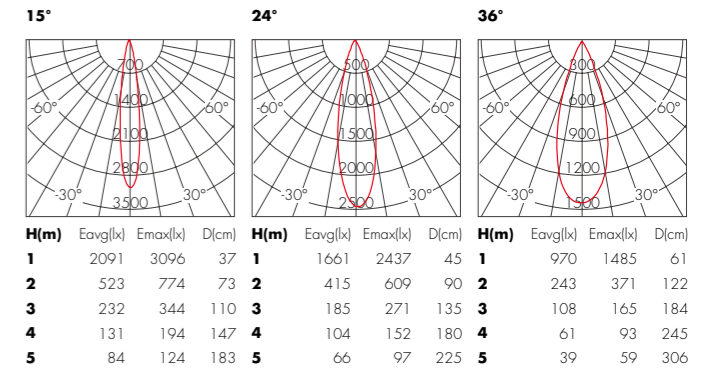

DDI085Y 15W

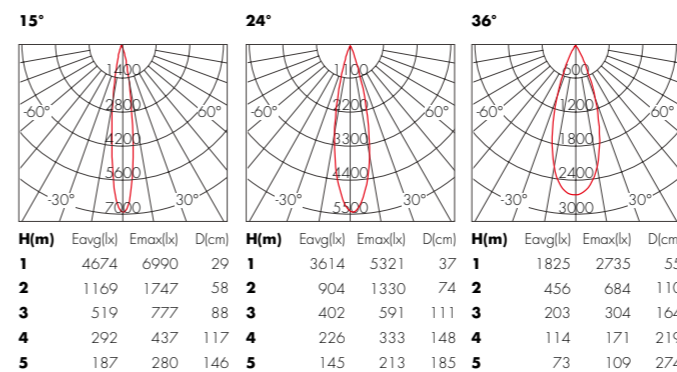

Accessories

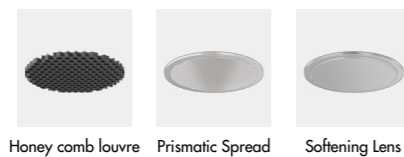

Secondary Reflector

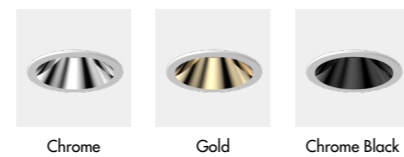

Colour Filter

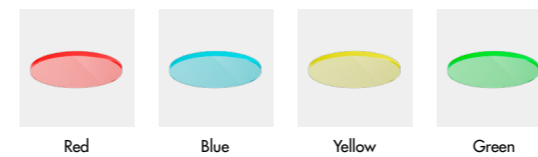



	DDI065X recessed	DDI075X recessed	DDI085X recessed	DSI075X recessed	DSI075T recessed
General Information					
Optics	15°/24°/36° Fixed	15°/24°/36° Fixed	15°/24°/36° Fixed	15°/24°/36° Adjustable	15°/24°/36° Adjustable
System Power (Watt)	5W	7W	9W	7W	7W
System Luminous flux (lm)	280lm	500lm	700lm	500lm	420lm
Driver parameters	36V/110mA	36V/160mA	36V/210mA	36V/160mA	36V/160mA
Cut out (mm)	Φ65	Φ75	Φ85	Φ75	Φ75

Technical Details

Light Source	LED COB
Colour temperature	2700K/3000K/4000K
CRI (Ra/R9)	RA>90/R9>50
Colour Consistency	SDCM<3
UGR	<16
IP-rated	IP20
Lifetime	>50,000h
Warranty	3 Years/5 Years
Driver	ON/OFF, Phase, 0-10V, Dali

Dimensions (mm)

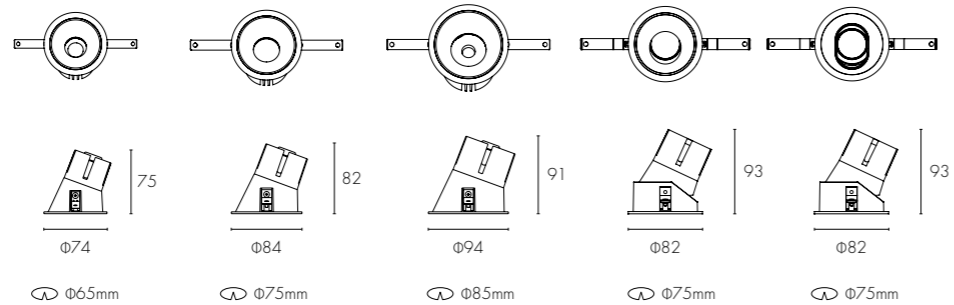

PHOTOMETRIC

DDI065X 5W

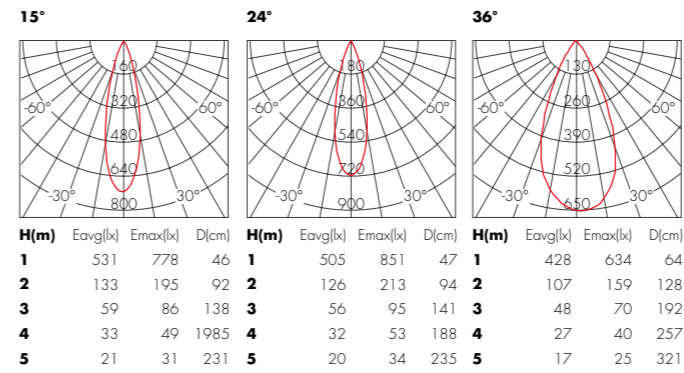

DDI075X 7W

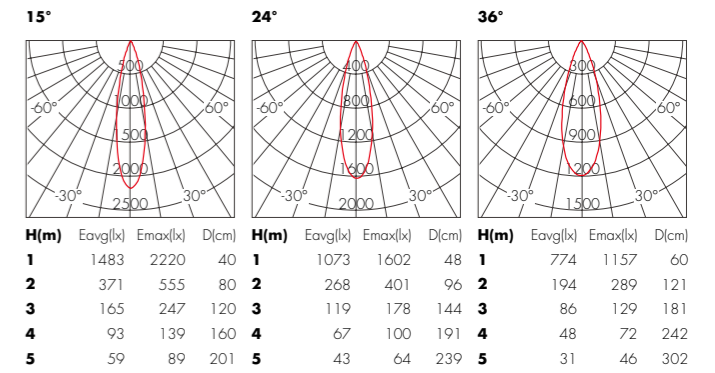

DDI085X 9W

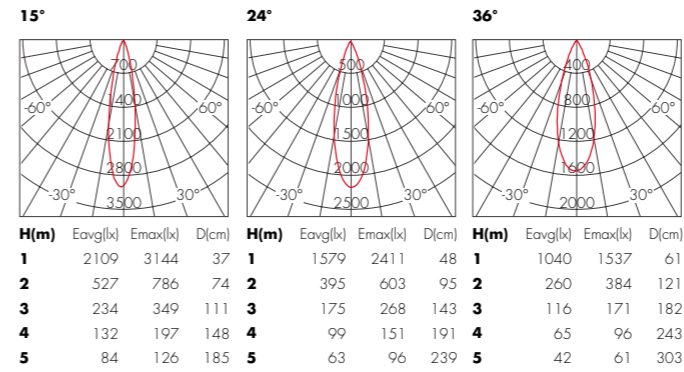

DSI075X 7W

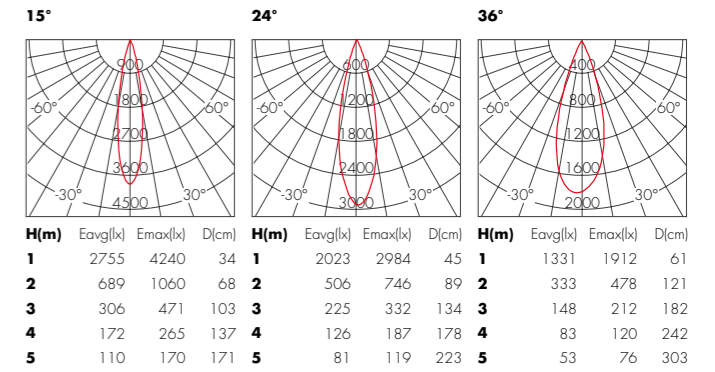

DSI075T 7W

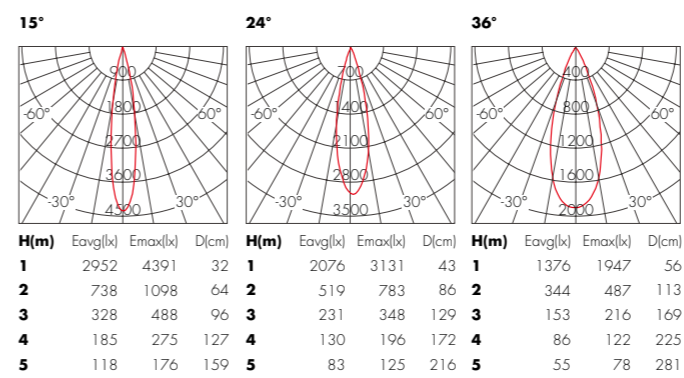

Accessories

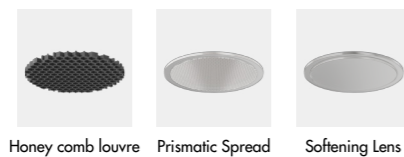

Secondary Reflector

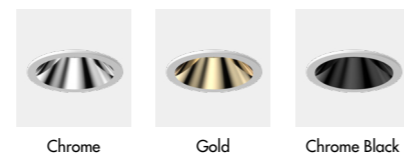

Colour Filter

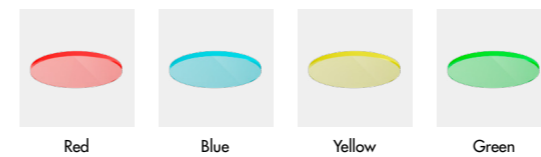



DDI040D recessed **DDI055D** recessed **DDI065D** recessed **DDI075D** recessed **DDI085D** recessed

General Information

Optics	10°/15°/24° Fixed	15°/24°/36° Fixed	15°/24°/36° Fixed	15°/24°/36° Fixed	15°/24°/36° Fixed
System Power (Watt)	5W	5W	7W	9W	15W
System Luminous flux (lm)	250lm	300lm	500lm	680lm	1050lm
Driver parameters	3V/1000mA	36V/110mA	36V/160mA	36V/210mA	36V/360mA
Cut out (mm)	Φ40	Φ55	Φ65	Φ75	Φ85

Technical Details

Light Source	LED SMD	LED COB
Colour temperature	2700K/3000K/4000K	
CRI (Ra/R9)	RA>90/R9>50	
Colour Consistency	SDCM<5	SDCM<3
UGR	<16	
IP-rated	IP20	
Lifetime	>50,000h	
Warranty	3 Years/5 Years	
Driver	ON/OFF, Phase, 0-10V, Dali	

Dimensions (mm)

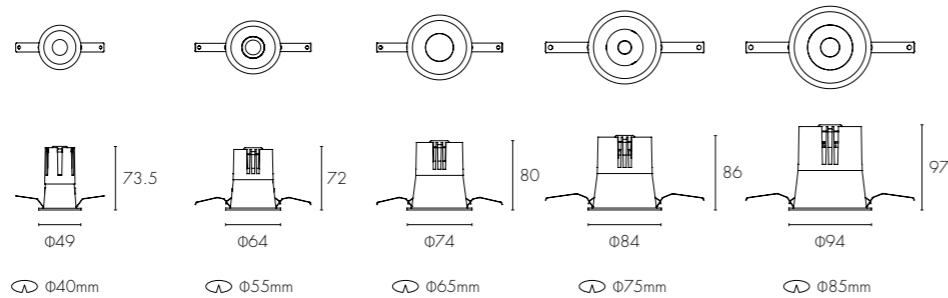

PHOTOMETRIC

DDI040D 5W

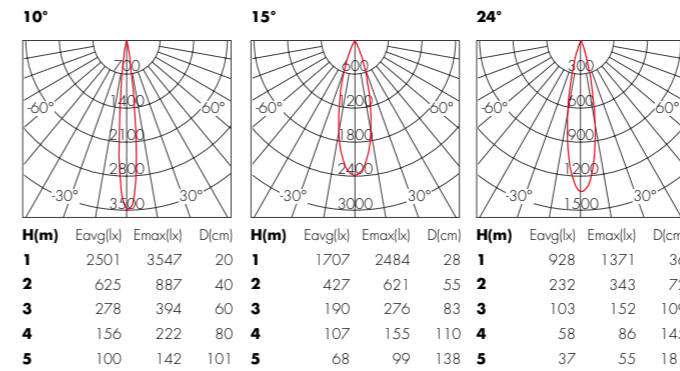

DDI055D 5W

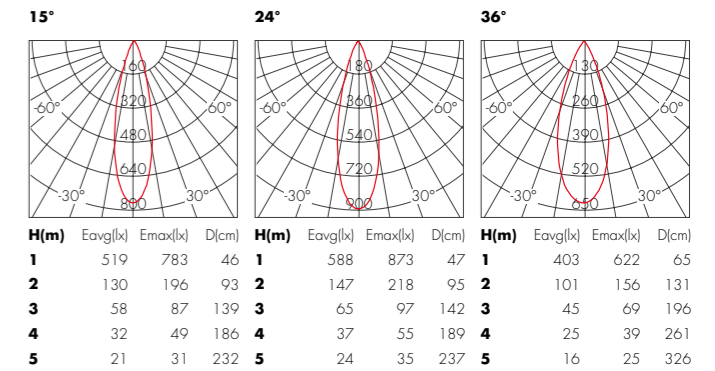

DDI065D 7W

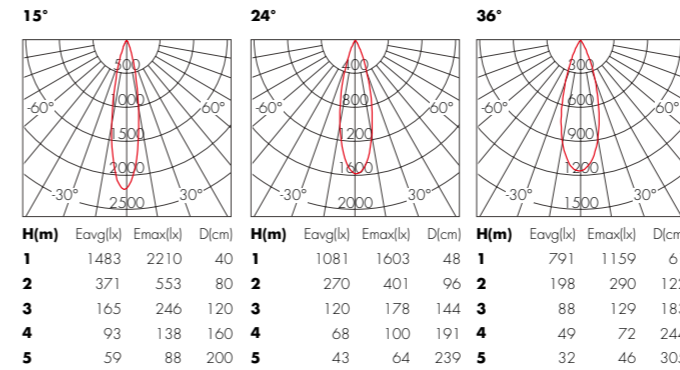

DDI075D 9W

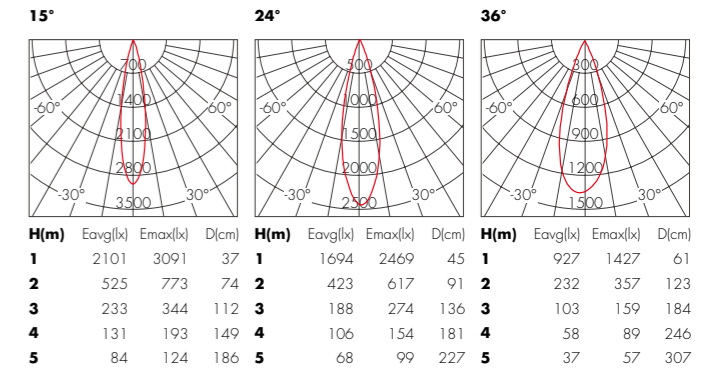

DDI085D 15W

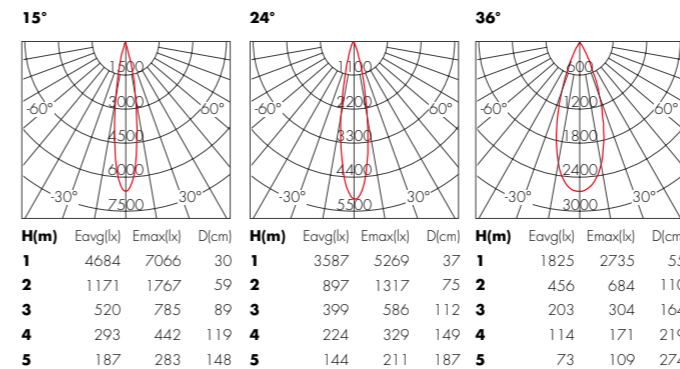

Accessories



Honey comb louvre Prismatic Spread Softening Lens

Finishes



White Black

Colour Filter

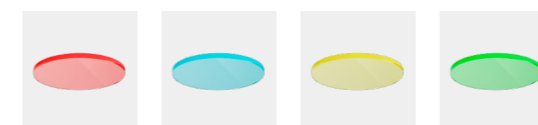

Red Blue Yellow Green



	DDIO40F recessed	DDIO55F recessed	DDIO65F recessed	DDIO75F recessed	DDIO85F recessed
General Information					
Optics	10°/15°/24° Fixed	15°/24°/36° Fixed	15°/24°/36° Fixed	15°/24°/36° Fixed	15°/24°/36° Fixed
System Power (Watt)	5W	5W	7W	9W	15W
System Luminous flux (lm)	250lm	300lm	500lm	680lm	1050lm
Driver parameters	3V/1000mA	36V/110mA	36V/160mA	36V/210mA	36V/360mA
Cut out (mm)	40x40	55x55	65x65	75x75	85x85

Technical Details

Light Source	LED SMD	LED COB
Colour temperature	2700K/3000K/4000K	
CRI (Ra/R9)	RA>90/R9>50	
Colour Consistency	SDCM<5	SDCM<3
UGR	<16	
IP-rated	IP20	
Lifetime	>50,000h	
Warranty	3 Years/5 Years	
Driver	ON/OFF, Phase, 0-10V, Dali	

Dimensions (mm)

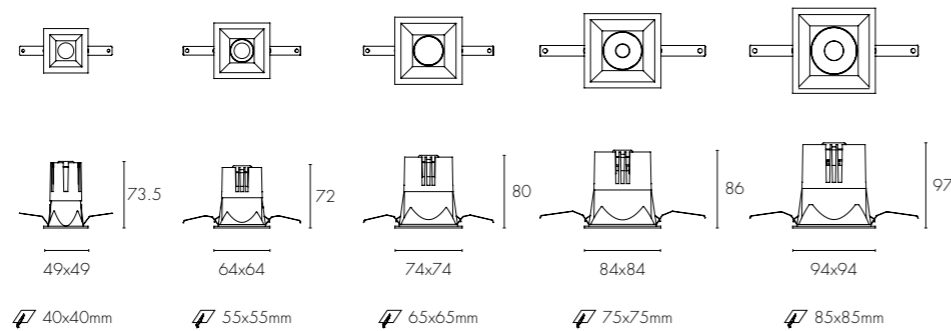

PHOTOMETRIC

DDIO40F 5W

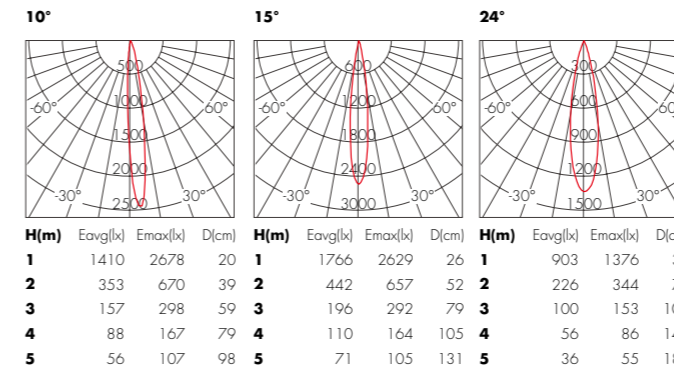

DDIO55F 5W

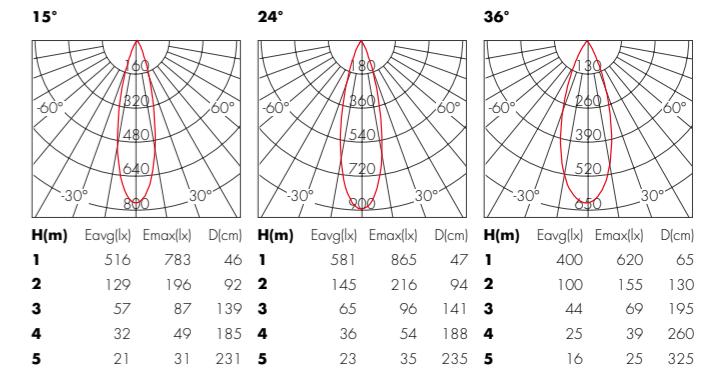

DDIO65F 7W

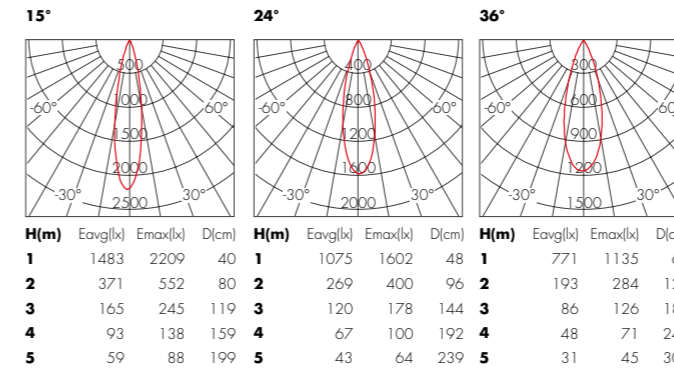

DDIO75F 9W

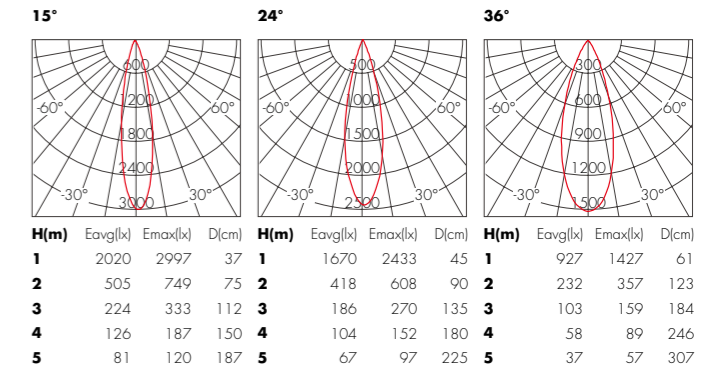

DDIO85F 15W

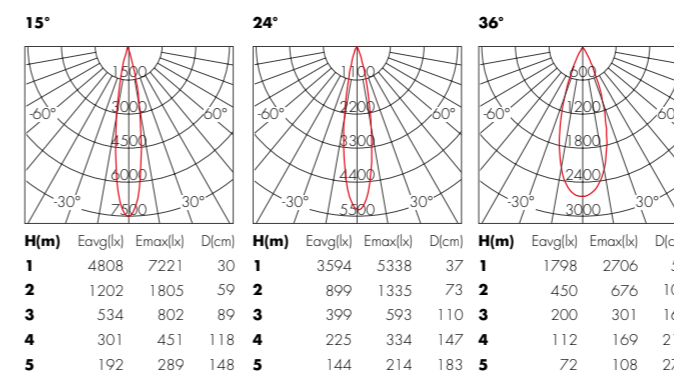

Accessories



Honey comb louvre | Prismatic Spread | Softening Lens

Finishes

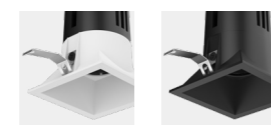

White | Black

Colour Filter

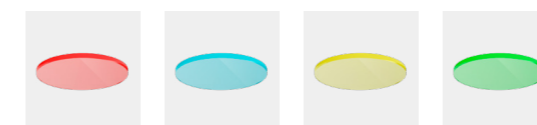

Red | Blue | Yellow | Green



DDI065Z
recessed

DDI075Z
recessed

DDI085Z
recessed

General Information

Optics	15°/24°/36° Fixed	15°/24°/36° Fixed	15°/24°/36° Fixed
System Power (Watt)	5W	7W	9W
System Luminous flux (lm)	280lm	500lm	700lm
Driver parameters	36V/110mA	36V/160mA	36V/210mA
Cut out (mm)	65x65	75x75	85x85

Technical Details

Light Source	LED COB
Colour temperature	2700K/3000K/4000K
CRI (Ra/R9)	RA>90/R9>50
Colour Consistency	SDCM<3
UGR	<16
IP-rated	IP20
Lifetime	>50,000h
Warranty	3 Years/5 Years
Driver	ON/OFF, Phase, 0-10V, Dali

Dimensions (mm)

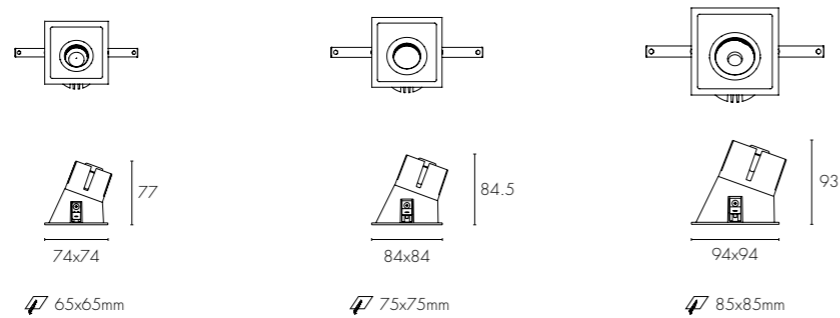

PHOTOMETRIC

DDI065Z 5W

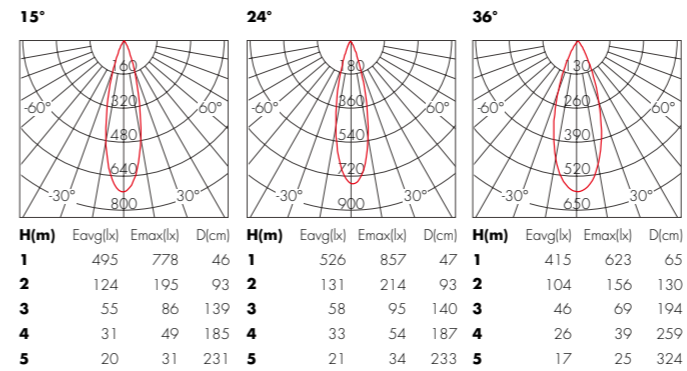

DDI075Z 7W

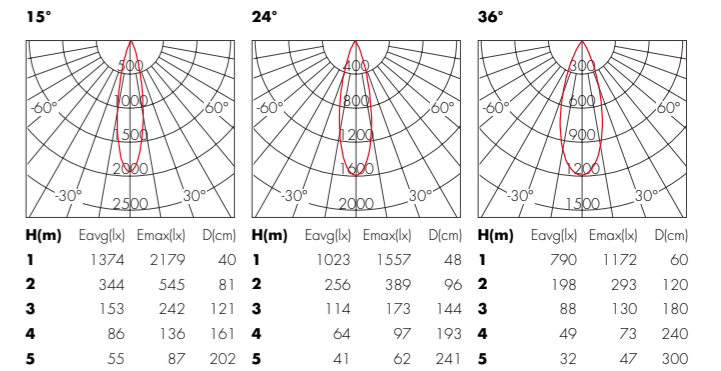

DDI085Z 9W

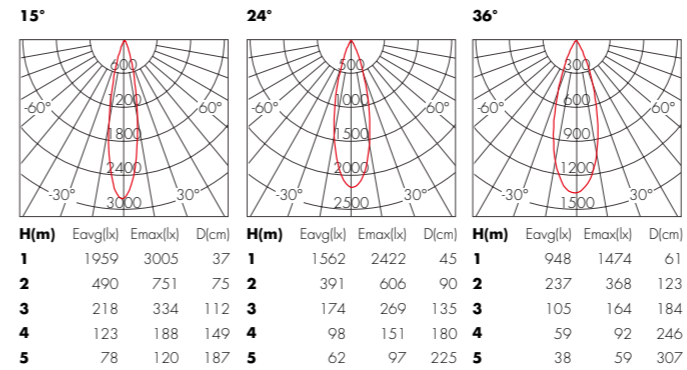

Accessories

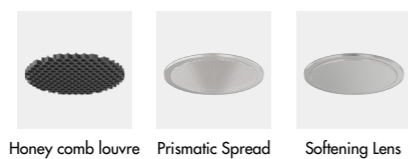

Finishes



Colour Filter

